

ASI-T-200CA2FN/D

Item	Contents	Unit
Size	2.0	inch
Resolution	176(RGB) x 20	/
Interface	8bits/16bits CPU	/
Technology type	a-SiTFT	/
Pixel Configuration	RGB stripes	
Outline Dimension (W x H x D)	37.68x51.30x2.25	mm
Active Area	31.68x 39.60	mm
Display Mode	Transmissive NormallyWhite	/
Backlight Type	LED	/
Driver IC	ILI9225B	

Record of Revision

Date	Revision No.	Summary
2011-09-13	1.0	Rev 1.0 was issued

ASI-T-200CA2FN/D

1. Scope

This data sheet is to introduce the specification of ASI-T-200CA2FN/D active matrix TFT module. It is composed of a color TFT-LCD panel, driver ICs, FPC and a backlight unit. The 2.0" display area contains 176(RGB) x 220 pixels.

2. Application

Digital equipments which need color display, mobile phone, mobile navigator/video systems.

3. General Information

Item	Contents	Unit
Size	2.0	inch
Resolution	176(RGB) x 220	/
Interface	8bits/16bits CPU	/
Technology type	a-Si TFT	/
Pixel Configuration	RGB stripes	
Outline Dimension (W x H x D)	37.68x51.30x2.25	mm
Active Area	31.68 x 39.60	mm
Display Mode	Transmissive, Normally White	/
Backlight Type	LED	/
Driver IC	ILI9225B	

ASI-T-200CA2FN/D

5. Interface signals

NO.	SYMBOL	DISCRIPTION	REMARK
1~8	D15-D8	High 8 BIT Data bus	
9	GND	Ground	
10~17	D7-D0(GND)	Low 8 BIT Data bus	
18	VDD	TYP: 2.8 V	
19	VDD	TYP: 2.8 V	
20	RD	Read Enable	
21	WR	Write Enable	
22	RS	DATA OR COMMAND SELECTION	
23	CS	Chip Selection	
24	RESET	SYSTEM RESET	
25	IM0	MPU System interface Select	
26	GND	Ground	
27	A	Anode pin of backlight	
28	K1	Cathode pin OF backlight	
29	K2	Cathode pin OF backlight	
30	K3	Cathode pin OF backlight	
31	YU	NO CONNECT	
32	YD	NO CONNECT	
33	XL	NO CONNECT	
34	XR	NO CONNECT	
35	NC	NO CONNECT	
36	NC	NO CONNECT	

Notes:

	DB8- DB15	DB0- DB15
IM0	1	0

ASI-T-200CA2FN/D

6. Absolute maximum Ratings

6.1. Electrical Absolute max. ratings

Parameter	Symbol	Min.	Max.	Unit	Remark
Supply voltage for logic	VCC	-0.3	4.6	V	
Power voltage for LCD	VLCD	-0.3	18.5	V	
Input voltage for logic	VIN	-0.3	VCC+0.3	V	
Supply current	ILCD	--	20	mA	

6.2. Environment Conditions

Item	Symbol	MIN	MAX	Unit	Remark
Operating Temperature	TOPR	-20	70	°C	
Storage Temperature	TSTG	-30	80	°C	

ASI-T-200CA2FN/D

7. Electrical Specifications

7.1 Electrical characteristics

GND=0V, Ta=25°C

Item	Symbol	MIN	TYP	MAX	Unit	Remark
Supply voltage for logic	VCC	--	2.8	--	V	
Power voltage for LCD	VLCD	--	4.5	--	V	
Supply current for LCM	ILCD	--	3	12	mA	VCC = 2.8V

7.2 LED Backlight

Ta=25°C

Item	Symbol	MIN	TYP	MAX	Unit	Remark
Forward Current	IF	--	45	--	mA	VL = 3.2V
Forward Voltage	VF	--	3.2	--	V	

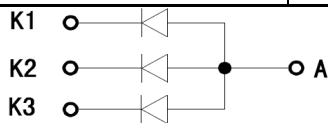

45mA 3.0-3.4V

7.3 BLOCK DIAGRAM

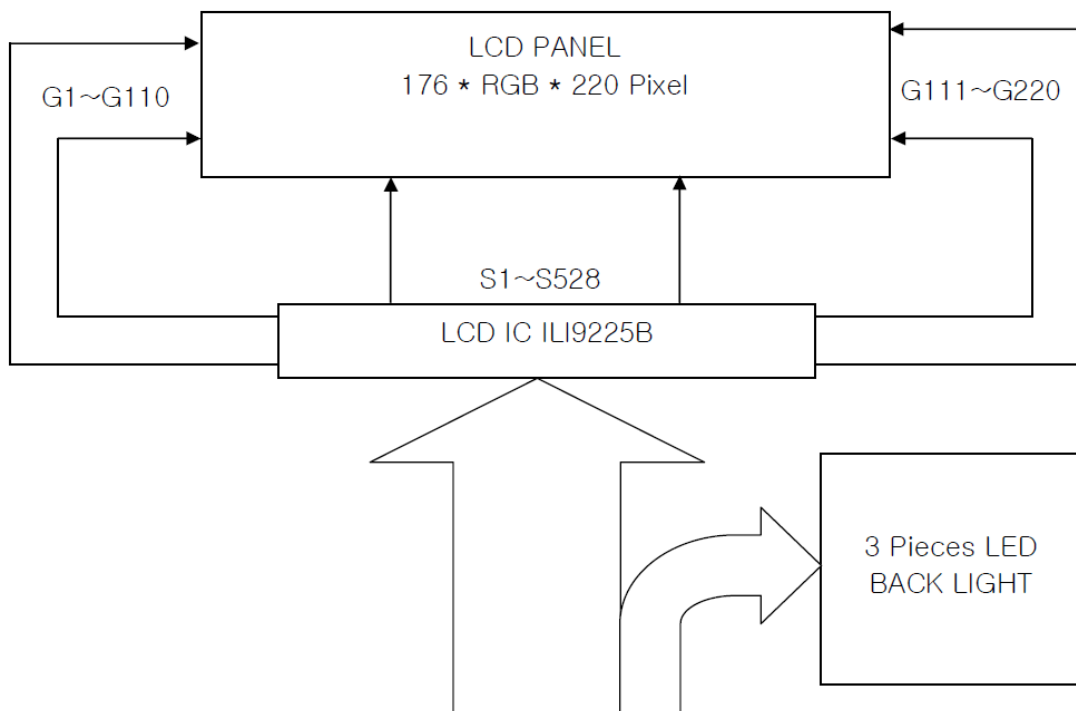

LCM 36 PINS INTERFACE

8. Command/AC Timing

8.1 CPU Interface Timing

Item	Symbol	Unit	Min.	Max.	Test Condition
Bus cycle time	Write	t_{CYCW}	ns	70	-
	Read	t_{CYCR}	ns	300	-
Write low-level pulse width	PW_{LW}	ns	15	500	-
Write high-level pulse width	PW_{HW}	ns	15	-	-
Read low-level pulse width	PW_{LR}	ns	150	-	-
Read high-level pulse width	PW_{HR}	ns	150	-	-
Write / Read rise / fall time	t_{WRr}/t_{WRf}	ns	-	15	-
Setup time	Write (RS to nCS, E/nWR)	t_{AS}	ns	10	-
	Read (RS to nCS, RW/nRD)			5	-
Address hold time	t_{AH}	ns	5	-	-
Write data set up time	t_{DSW}	ns	10	-	-
Write data hold time	t_H	ns	15	-	-
Read data delay time	t_{DDR}	ns	-	100	-
Read data hold time	t_{DHR}	ns	5	-	-

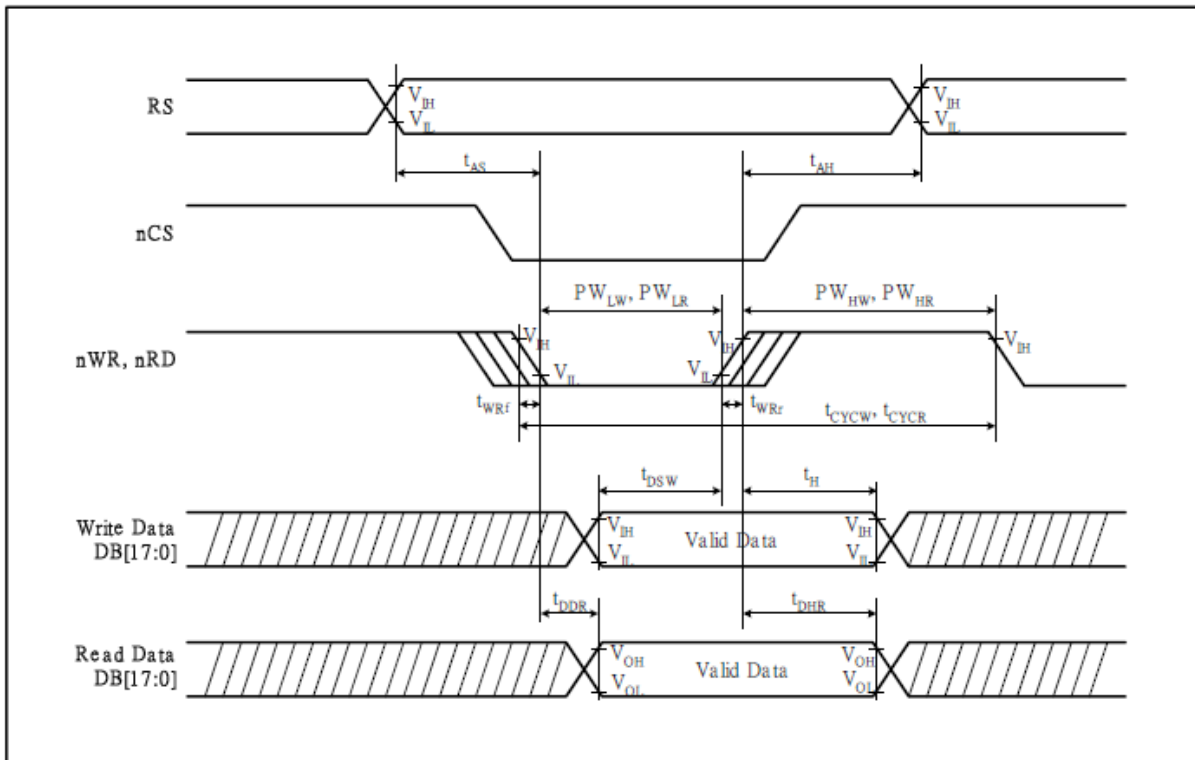

ASI-T-200CA2FN/D

9. Optical Specification

Ta=25°C

Item	Symbol	Condition	Min	Typ.	Max.	Unit	Remark
Contrast Ratio	CR	$\theta=0^\circ$	-	350	-		Note1 Note2
Response Time	Tr+ Tf	25°C	-	25	40	ms	Note1 Note3
View Angles	θT	CR ≥ 10	-	50	-	Degree	Note 4
	θB		-	20	-		
	θL		-	45	-		
	θR		-	45	-		
Chromaticity	Red	Brightness is on	x	0.579	0.629	0.679	Note5, Note1
			y	0.270	0.320	0.370	
	Green		x	0.240	0.290	0.340	
			y	0.558	0.608	0.658	
	Blue		x	0.094	0.144	0.194	
			y	0.078	0.128	0.178	
	White		x	0.259	0.309	0.359	
			y	0.295	0.345	0.395	
NTSC	S		--	60	--	%	Note5
Luminance	L		200	220	-	cd/m ²	Note1 Note6
Uniformity	U		75	-	-	%	Note1 Note7

Note 1: Definition of optical measurement system.

Temperature = 25°C (±3°C)

LED back-light: ON, Environment brightness < 150 lx

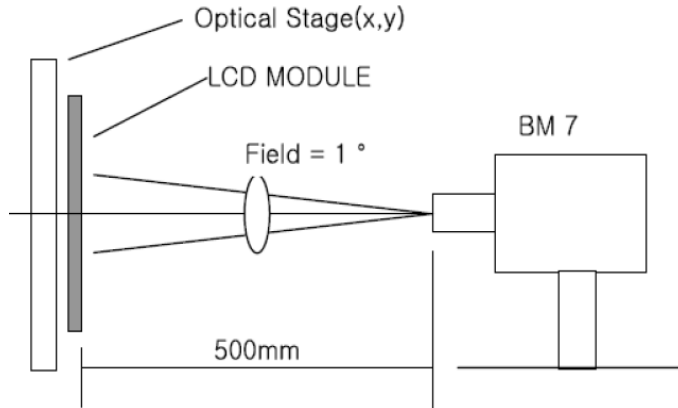

Note 2: Contrast ratio is defined as follow:

$$\text{Contrast Ratio} = \frac{\text{Surface Luminance with all white pixels}}{\text{Surface Luminance with all black pixels}}$$

Note 3: Response time is defined as follow:

Response time is the time required for the display to transition from black to white (Rise Time, Tr) and from white to black(Decay Time, Tf).

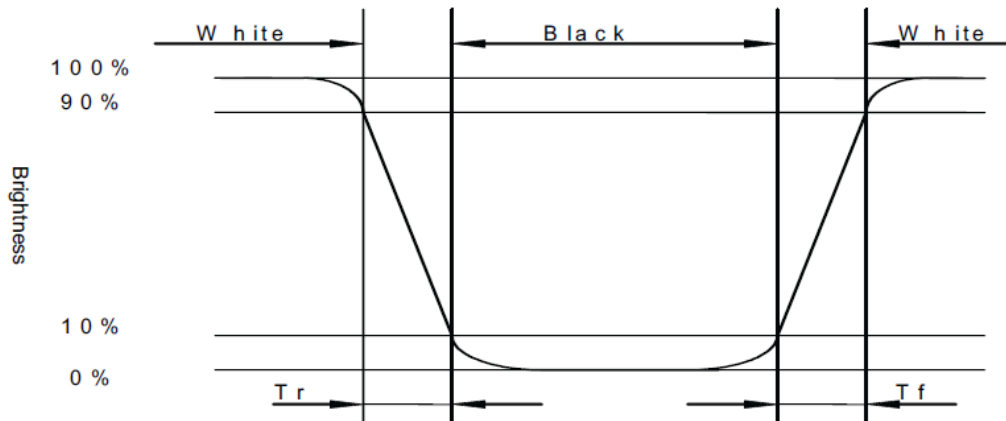

Note 4: Viewing angle range is defined as follow:

Viewing angle is measured at the center point of the LCD.

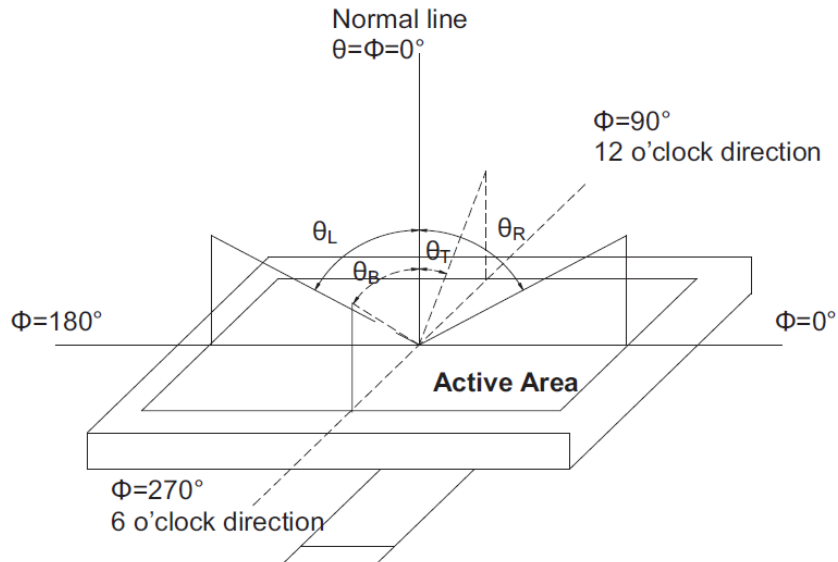

Note 5: Color chromaticity is defined as follow: (CIE1931)

Color coordinates measured at center point of LCD.

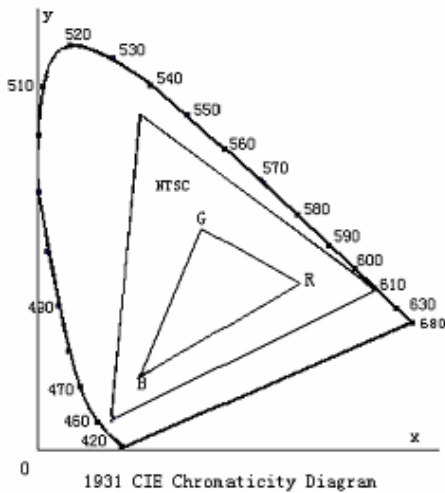

$$S = \frac{\text{area of RGB triangle}}{\text{area of NTSC triangle}} \times 100\%$$

Note 6: Luminance is defined as follow:

Luminance is defined as the brightness of all pixels “White” at the center of display area on optimum contrast.

Note 7: Luminance Uniformity is defined as follow:

Active area is divided into 9 measuring areas (Refer Fig. 2). Every measuring point is placed at the center of each measuring area.

$$\text{Uniformity}(U) = \frac{\text{Minimum Luminance(brightness) in 9 points}}{\text{Maximum Luminance(brightness) in 9 points}}$$

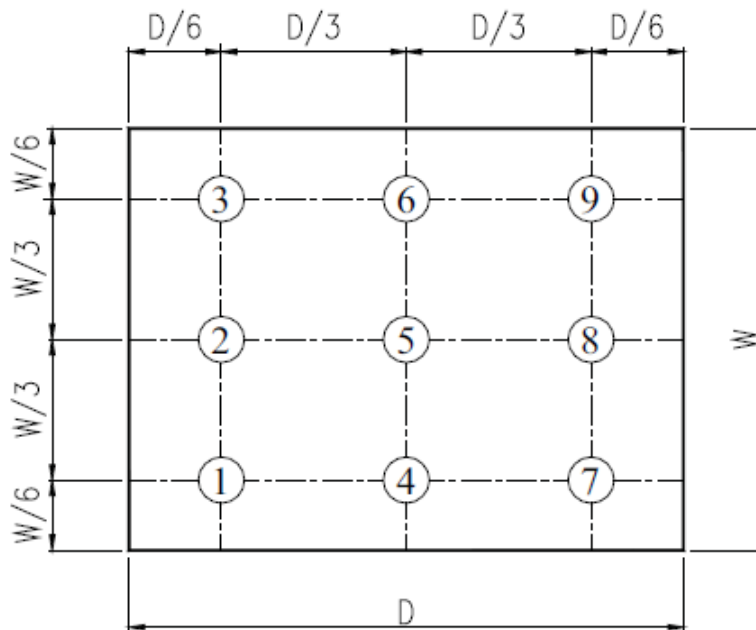

Fig. 2 Definition of uniformity

10. Environmental / Reliability Tests

No	Test Item	Condition	Judgment criteria
1	High Temp Operation	Ts=+70°C, 120hrs	Per table in below
2	Low Temp Operation	Ta=-20°C, 120hrs	Per table in below
3	High Temp Storage	Ta=+80°C, 120hrs	Per table in below
4	Low Temp Storage	Ta=-30°C, 120hrs	Per table in below
5	High Temp & High Humidity Storage	Ta=+40°C, 90% RH 120 hours	Per table in below (polarizer discoloration is excluded)
6	Thermal Shock (Non-operation)	-30°C 30 min~+80°C 30 min, Change time:5min, 10 Cycles	Per table in below
7	ESD (Operation)	C=150pF, R=330Ω , 5points/panel Air:±8KV, 5times; Contact:±4KV, 5 times;	Per table in below
8	Vibration (Non-operation)	Frequency range:10~55Hz, Stroke:1.5mm Sweep:10Hz~55Hz~10Hz 2 hours for each direction of X.Y.Z.	Per table in below
9	Shock (Non-operation)	60G 6ms, ±X,±Y,±Z 3times, for each direction	Per table in below
10	Package Drop Test	Height:80 cm, 1 corner, 3 edges, 6 surfaces	Per table in below

INSPECTION	CRITERION(after test)
Appearance	No Crack on the FPC, on the LCD Panel
Alignment of LCD Panel	No Bubbles in the LCD Panel No other Defects of Alignment in Active area
Electrical current	Within device specifications
Function / Display	No Broken Circuit, No Short Circuit or No Black line No Other Defects of Display

11. Precautions for Use of LCD Modules

11.1 Safety

The liquid crystal in the LCD is poisonous. Do not put it in your mouth. If the liquid crystal touches your skin or clothes, wash it off immediately using soap and water.

11.2 Handling

- A. The LCD and touch panel is made of plate glass. Do not subject the panel to mechanical shock or to excessive force on its surface.
- B. Do not handle the product by holding the flexible pattern portion in order to assure the reliability
- C. Transparency is an important factor for the touch panel. Please wear clear finger sacks, gloves and mask to protect the touch panel from finger print or stain and also hold the portion outside the view area when handling the touch panel.
- D. Provide a space so that the panel does not come into contact with other components.
- E. To protect the product from external force, put a covering lens (acrylic board or similar board) and keep an appropriate gap between them.
- F. Transparent electrodes may be disconnected if the panel is used under environmental conditions where dew condensation occurs.
- G. Property of semiconductor devices may be affected when they are exposed to light, possibly resulting in IC malfunctions.
- H. To prevent such IC malfunctions, your design and mounting layout shall be done in the way that the IC is not exposed to light in actual use.

11.3 Static Electricity

- A. Ground soldering iron tips, tools and testers when they are in operation.
- B. Ground your body when handling the products.
- C. Power on the LCD module before applying the voltage to the input terminals.
- D. Do not apply voltage which exceeds the absolute maximum rating.
- E. Store the products in an anti-electrostatic bag or container.

11.4 Storage

- A. Store the products in a dark place at $+25^{\circ}\text{C} \pm 10^{\circ}\text{C}$ with low humidity (40% RH to 60% RH). Don't expose to sunlight or fluorescent light.
- B. Storage in a clean environment, free from dust, active gas, and solvent.

11.5 Cleaning

- A. Do not wipe the touch panel with dry cloth, as it may cause scratch.
- B. Wipe off the stain on the product by using soft cloth moistened with ethanol. Do not allow ethanol to get in between the upper film and the bottom glass. It may cause peeling issue or defective operation. Do not use any organic solvent or detergent other than ethanol.

11.6 Cautions for installing and assembling

Bezel edge must be positioned in the area between the Active area and View area. The bezel may press the touch screen and cause activation if the edge touches the active area. A gap of approximately 0.5mm is needed between the bezel and the top electrode. It may cause unexpected activation if the gap is too narrow. There is a tolerance of 0.2 to 0.3mm for the outside dimensions of the touch panel and tail. A gap must be made to absorb the tolerance in the case and connector.

