



# ALL SHORE INDUSTRIES, INC.

## SPECIFICATION FOR LIQUID CRYSTAL DISPLAY MODULE

**MODULE #: ASI-B-2406CS-GC-\_WS/W**

- (1) NUMBER OF DOT----- 240 W\* 64 H DOTS
- (2) MODULE SIZE----- 140.0 W \* 62.0 H \* "C" T (Max) mm
- (3) EFFECTIVE AREA ----- 116.0 W \* 37.0 H mm
- (4) ACTIVE AREA----- 105.57 W \* 31.97 H mm
- (5) DOT SIZE ----- 0.41 W \* 0.47 H mm
- (6) DOT PITCH----- 0.44 W \* 0.50 H mm



**MODEL NO : ASI-B-2406CS-GC-\_WS/W**

RECORDS OF REVISION		DOC . FIRST ISSUE May, 2003
DATE	REVISED DRAWING NO.	SUMMARY



MODEL NO : ASI-B-2406CS-GC-\_WS/W

**LCD MODULE PART NUMBERING SYSTEM**

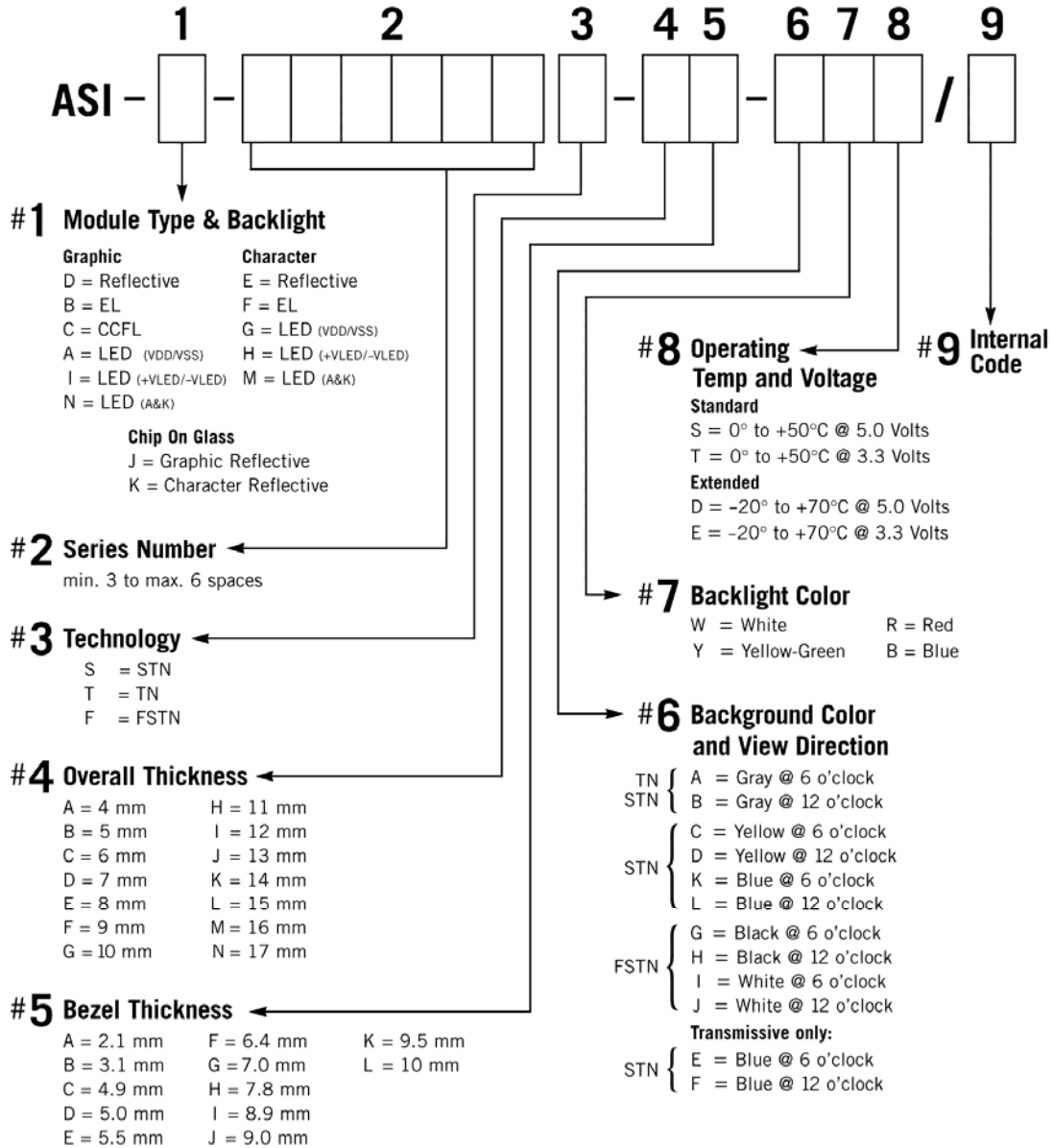

NOTE: Some options may not be available in specific modules. Please contact your Sales Representative to check availability.



**MODEL NO : ASI-B-2406CS-GC-\_WS/W**

1. GENERAL SPECIFICATIONS

1.1 GENERAL SPECIFICATIONS

PLEASE REFER TO :

"CUSTOMER ACCEPTANCE STANDARD SPECIFICATIONS :

1.2 APPLICATION NOTES FOR CONTROLLER / DRIVER :

PLEASE REFER TO :

CUSTOMER ACCEPTANCE STANDARD SPECIFICATIONS :

1.3 THIS INDIVIDUAL SPECIFICATIONS IS PRIOR TO GENERAL SPECIFICATIONS .

2. MECHANICAL SPECIFICATIONS

- (1) NUMBER OF DOT----- 240 W\* 64 H DOTS
- (2) MODULE SIZE----- 140.0 W \* 62.0 H \* "C" T (Max) mm
- (3) EFFECTIVE AREA----- 116.0 W \* 37.0 H mm
- (4) ACTIVE AREA----- 105.57 W \* 31.97 H mm
- (5) DOT SIZE ----- 0.41 W \* 0.47 H mm
- (6) DOT PITCH----- 0.44 W \* 0.50 H mm



## MODEL NO : ASI-B-2406CS-GC-\_WS/W

### 3. ABSOLUTE MAXIMUM RATINGS

#### 3.1 ELECTRICAL ABSOLUTE MAXIMUM RATINGS.

<i>I T E M</i>	<i>SYMBOL</i>	<i>MIN.</i>	<i>MAX.</i>	<i>UNIT</i>	<i>COMMENT</i>
POWER SUPPLY FOR LOGIC	V <sub>DD</sub> -V <sub>SS</sub>	0	6.0	V	-----
INPUT VOLTAGE	V <sub>I</sub>	V <sub>SS</sub>	V <sub>DD</sub>	V	-----
STATIC ELECTRICITY	-----	-----	100	V	NOTE (1)
POWER SUPPLY FOR EL BACKLIGHT	V <sub>EL</sub>	-----	AC200	V <sub>rms</sub>	f <sub>EL</sub> =1.0KHz 60 SEC.MAX
	f <sub>EL</sub>	-----	2.0	KHz	AC115 V <sub>rms</sub> 60 SEC.MAX
POWER SUPPLY FOR LED	V <sub>LED</sub>	-----	5.0	V	-----

NOTE (1): ELECTRO-STATIC DISCHARGE RESISTANCE IS TESTED BY CHARGING A 200PF CAPACITOR AND DISCHARGING IT BY CONTACT WITH A INTERFACE CONNECTOR PIN.

#### 3.3 ENVIRONMENTAL ABSOLUTE MAXIMUM RATINGS .

<i>I T E M</i>	<i>OPERATING</i>		<i>STORAGE</i>		<i>COMMENT</i>
	<i>MIN.</i>	<i>MAX.</i>	<i>MIN.</i>	<i>MAX.</i>	
AMBIENT TEMPERATURE	-20°C	70°C	-20°C	70°C	-----
HUMIDITY	NOTE (2)		NOTE (2)		NO CONDENSATION
VIBRATION NOTE (3)	-----	0.5G	-----	2G	10~300HZ XYZ DIRECTIONS 1 Hr EACH
SHOCK NOTE (3)	-----	3G	-----	50G	10 msec XYZ DIRECTIONS 1 TIME EACH
CORROSIVE GAS	NOT ACCEPTABLE		NOT ACCEPTABLE		-----

NOTE (2): Ta ≤ 50°C: 90% RH MAX.

Ta > 50°C: ABSOLUTE HUMIDITY MUST BE LOWER THAN THE HUMIDITY OF 90% RH AT 50°C. (80%RH AT 60°C)

NOTE (3): 1G = 9.8 m/s<sup>2</sup>



### MODEL NO : ASI-B-2406CS-GC-\_WS/W

#### 4. ELECTRICAL CHARACTERISTICS

<i>I T E M</i>	<i>SYMBOL</i>	<i>CONDITION</i>	<i>MIN.</i>	<i>TYP.</i>	<i>MAX.</i>	<i>UNIT</i>	
POWER SUPPLY VOLTAGE FOR CIRCUIT	$V_{DD}-V_{SS}$	-----	4.75	5.0	5.25	V	
INPUT VOLTAGE	$V_{IH}$	H LEVEL	2.0	-----	$V_{DD}$	V	
	$V_{IL}$	L LEVEL	0	-----	0.8	V	
OUTPUT VOLTAGE	$V_{OH}$	$I_{OH} = -0.3 \text{ mA}$	2.4	-----	-----	V	
	$V_{OL}$	$I_{OH} = 3.0 \text{ mA}$	-----	-----	0.4	V	
POWER SUPPLY CURRENT	$I_{DD}$	$V_{DD}-V_{SS} = 5.0 \text{ V}$	-----	10.0	20.0	mA	
RECOMMENDED LCD DRIVING VOLTAGE, NOTE(1)	$V_{DD}-V_{O}$	STN/ FSTN DUTY =1/64 $\Phi=10^\circ$ NOTE(2)	$T_a=-20^\circ\text{C}$	-----	8.9	-----	V
		$T_a=25^\circ\text{C}$	-----	8.5	-----	V	
		$T_a=70^\circ\text{C}$	-----	8.1	-----	V	
POWER SUPPLY CURRENT FOR EL BACKLIGHT	$I_{EL}$	$V_{EL} = 115V_{rms}$ $f_{EL} = 400\text{Hz}$	-----	8.0	-----	mArms	
POWER SUPPLY CURRENT FOR LED	$I_{LED}$	NOTE(3)	-----	NOTE(3)	NOTE(3)	mA	

NOTE (1): RECOMMENDED LCD DRIVING VOLTAGE MAY FLUCTUATE ABOUT  $\pm 0.5\text{V}$  BY EACH MODULE.

(2):  $\theta = 0^\circ$  : VIEWING DIRECTION AT 6 O'CLOCK

$\theta = 180^\circ$  : VIEWING DIRECTION AT 12 O'CLOCK

(3): LED CURRENT FOR DIFFERENT LED BACKLIGHT TYPE

<i>LED B.L TYPE</i>	<i>CONDITION</i>	<i>I<sub>LED</sub></i>				<i>LED COLOR</i>
		<i>MIN.</i>	<i>TYP.</i>	<i>MAX.</i>	<i>UNIT.</i>	
LED B.L (ARRAY)	$V_{DD} = 5.0\text{V}$	-----	280	420	mA	YELLOW-GREEN · RED AMBER · ORANGE
LED B.L (EDGE)	$V_{LED} = 4.0\text{V}$	-----	75	100	mA	BLUE · WHITE PURE-GREEN



## MODEL NO : ASI-B-2406CS-GC-\_WS/W

### 5. OPTICAL CHARACTERISTICS.

$T_a = 25^{\circ}\text{C}$      $V_{DD} = 5.0\text{V}$

#### STN TYPE LCD

$T_a = 25^{\circ}\text{C}$      $V_{DD}-V_O = 8.5\text{V}$

ITEM	SYMBOL	CONDITION	MIN.	TYP.	MAX.	UNIT	NOTE
VIEWING ANGLE	$\Phi 2-\Phi 1$	$K = 2.0$ NOTE(1)	30	40	----	deg.	NOTE(2)
CONTRAST RATIO	K	$\Phi = 10^{\circ}$ NOTE(1)	3.0	4.0	----	----	NOTE(2)
RESPONSE TIME	tr (rise)	$\Phi = 10^{\circ}$ NOTE(1)	----	200	350	ms	NOTE(2)
	tf (fall)	$\Phi = 10^{\circ}$ NOTE(1)	----	300	400	ms	NOTE(2)

#### FSTN、STN BLUE TYPE LCD

$T_a = 25^{\circ}\text{C}$      $V_{DD}-V_O = 8.5\text{V}$

ITEM	SYMBOL	CONDITION	MIN.	TYP.	MAX.	UNIT	NOTE
VIEWING ANGLE	$\Phi 2-\Phi 1$	$K = 2.0$ NOTE(1)	30	40	----	deg.	NOTE(2)
CONTRAST RATIO	K	$\Phi = 10^{\circ}$ NOTE(1)	4.0	5.0	----	----	NOTE(2)
RESPONSE TIME	tr (rise)	$\Phi = 10^{\circ}$ NOTE(1)	----	200	350	ms	NOTE(2)
	tf (fall)	$\Phi = 10^{\circ}$ NOTE(1)	----	300	400	ms	NOTE(2)

#### Brightness for LCM backlight

SYMBOL	CONDITION	MIN.	TYP.	MAX.	UNIT	LED TYPE	NOTE
B	$\Phi = 0^{\circ}$ $\theta = 0^{\circ}$	4.0	----	----	cd/m <sup>2</sup>	EL BACKLIGHT	NOTE(2) NOTE(3)
		5.0	----	----		YELLOW-GREEN、RED AMBER、ORANGE	
		6.0	----	----		BLUE、WHITE、 PURE-GREEN	

NOTE (1):  $\theta = 0^{\circ}$  : VIEWING DIRECTION AT 6 O'CLOCK

$\theta = 180^{\circ}$  : VIEWING DIRECTION AT 12 O'CLOCK

NOTE (2): SEE CUSTOMER ACCEPTANCE STANDARD SPECIFICATION FOR DEFINITION OF OPTICAL CHARACTERISTICS.

NOTE (3): UNDER NORMAL TEMPERATURE AND HUMIDITY IN A DARK ROOM.



MODEL NO : ASI-B-2406CS-GC-WS/W

6. OUTLINE DIMENSION

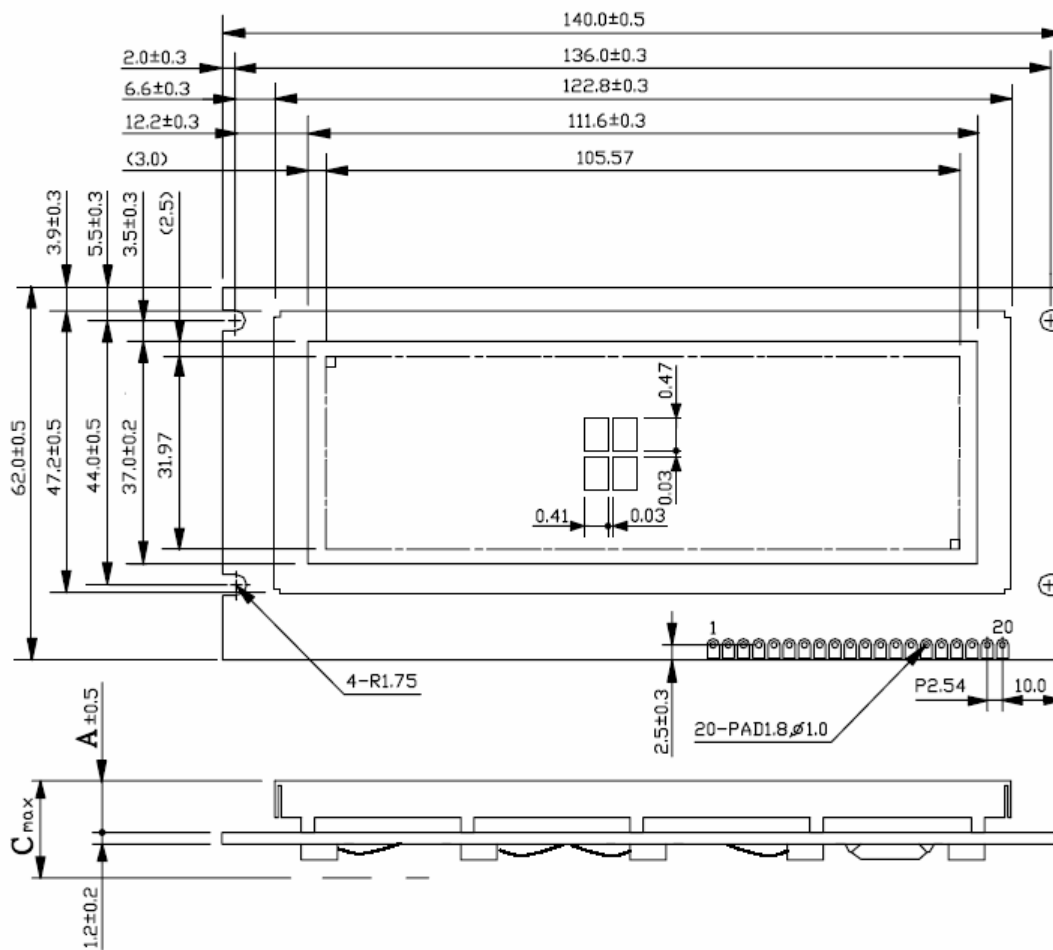

TYPE	A	C
LED B.L	10.0	15.0
EL & NO B.L	4.9	9.5

NOTE :  
 1.UNIT : mm  
 2.SCALE : NTS



**MODEL NO : ASI-B-2406CS-GC-\_WS/W**

PIN NO.	SYMBOL	FUNCTION
1	VSS	POWER SUPPLY ( GND )
2	VDD	POWER SUPPLY ( +5.0V )
3	Vo	OPERATING VOLTAGE FOR LCD DRIVING
4	RS	L : DATA INPUT H : INSTRUCTION CODE INPUT
5	$\overline{R/W}$	H: DATA READ (LCD MODULE → MPU) L: DATA WRITE (LCD MODULE ← MPU)
6	E	ENABLE SINGAL
7	DB0	DATA INPUT/OUTPUT (LSB)
8	DB1	DATA INPUT/OUTPUT
9	DB2	DATA INPUT/OUTPUT
10	DB3	DATA INPUT/OUTPUT
11	DB4	DATA INPUT/OUTPUT
12	DB5	DATA INPUT/OUTPUT
13	DB6	DATA INPUT/OUTPUT
14	DB7	DATA INPUT/OUTPUT (MSB)
15	$\overline{CS}$	L: CHIP ENABLE
16	$\overline{RES}$	L: RESET
17	VEE	POWER SUPPLY FOR LCD DRIVING OUTPUT
18	N.C	NO CONNECTION
19	A(+) (VEL)	POWER SUPPLY FOR LED BACKLIGHT (+) (POWER SUPPLY FOR EL)
20	K(-) (VEL)	POWER SUPPLY FOR LED BACKLIGHT (-) (POWER SUPPLY FOR EL)

**MODEL NO : ASI-B-2406CS-GC-\_WS/W**

**8. DETAIL DRAWING OF DOT MATRIX**

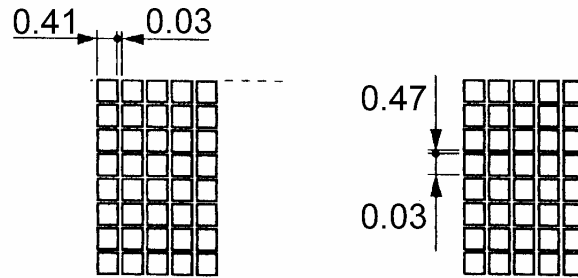

**9. BLOCK DIAGRAM**

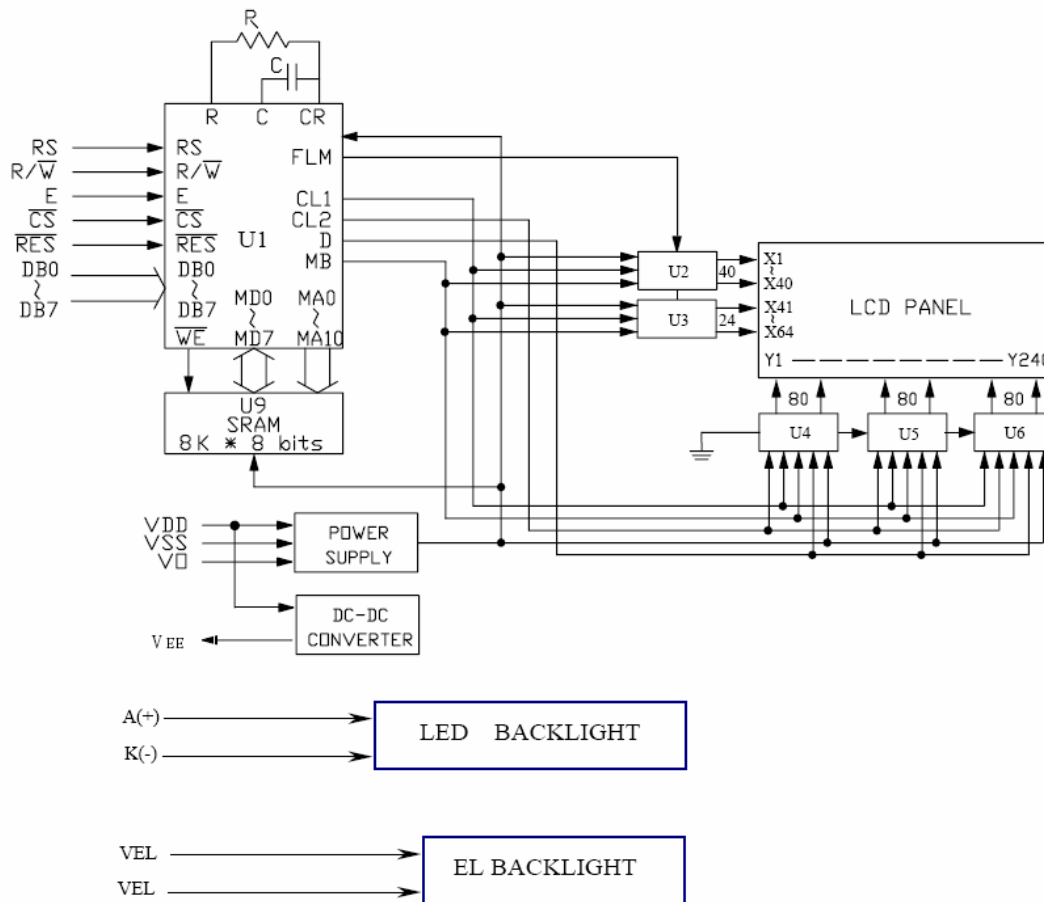

**MODEL NO : ASI-B-2406CS-GC-\_WS/W**

**10. POWER SUPPLY**

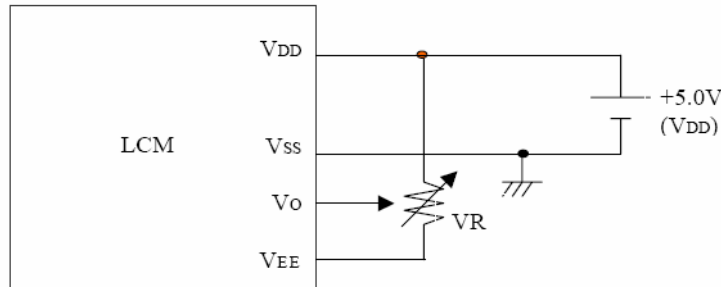

VDD-Vo: LCD DRIVING VOLTAGE  
VR: 200KΩ

**10.1 Power supply for backlight**

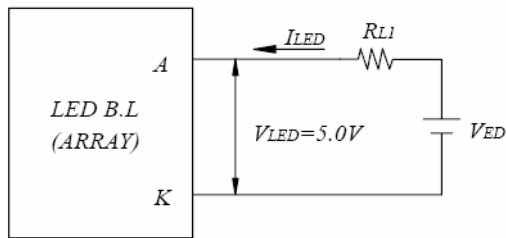
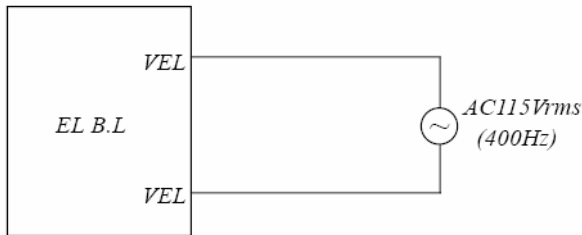

$$RL1 \geq (VED - VLED) / ILED, ILED \leq 420.0 \text{ mA (max)}$$

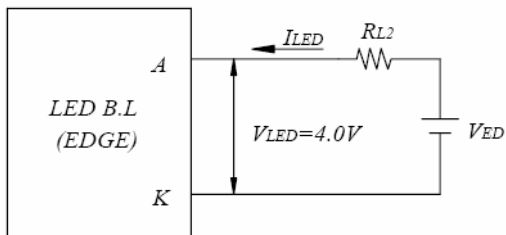

$$RL2 \geq (VED - VLED) / ILED, ILED \leq 100.0 \text{ mA (max)}$$